

Louis

THE NEW JEWEL CASE FOR YOUR FLAT SCREEN

A true multimedia platform, the LOUIS unit brings together various peripherals and offers a high volume of storage. With its unique and streamlined design, it conceals an integrated connection strip, to directly connect all roaming devices.



Louis

- A FURNITURE SYSTEM WITH CONNECTION STRIP AND HEIGHT AND DEPTH ADJUSTABLE SHELVES
- 3 finishes: aluminium, black or white
- 3 structures:
 - Pedestal stand
 - Column with manual screen swivel
 - Column with motorized TWIST® screen swivel
- Available assembled or non-assembled
- Manual rotation or motorized TWIST® screen swivel to watch TV wherever you are in the room
- Connection strip on front allows quick connections for MP3 players, cameras, computers etc...
- Cables concealed in the column
- Management system for electrical cables (mains, power strips...) screen connections and peripherals in the column and LIGHT MOTION® ambient lighting (on LIGHT® models)
- Room for 4 components
- Height and depth adjustable shelves, adapts to most component systems and home theaters



Connection strip (all models)



Motorized screen swivel (on TWIST® models)



NEW!
AVAILABLE IN 3 FINISHES BLACK ,
WHITE, ALUMINIUM
AVAILABLE IN ASSEMBLED
OR NON-ASSEMBLED



Ambient lighting (on LIGHT MOTION® models)



Pedestal stand

Aluminium finish

Also available in white and black finishes

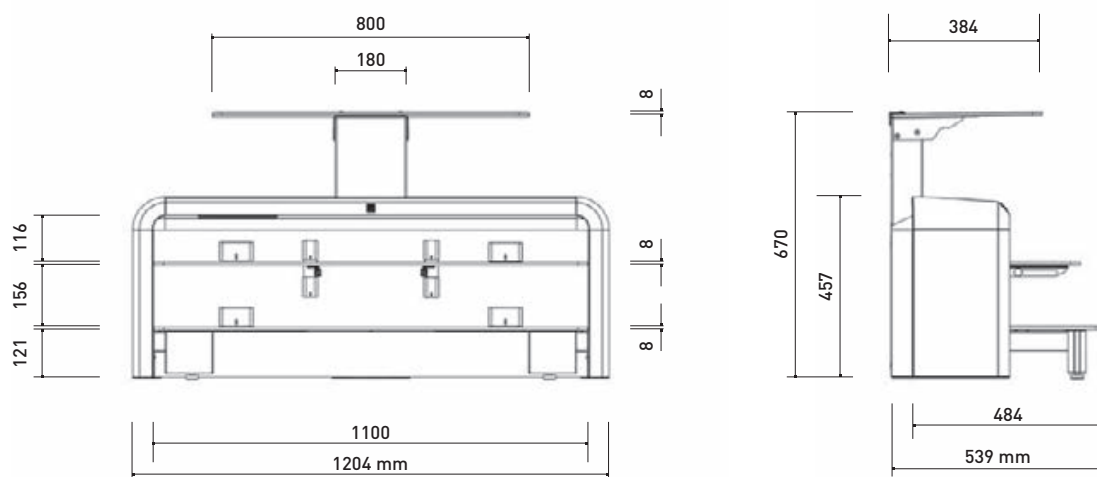



Stand with column

Aluminium finish

Also available in white and black finishes

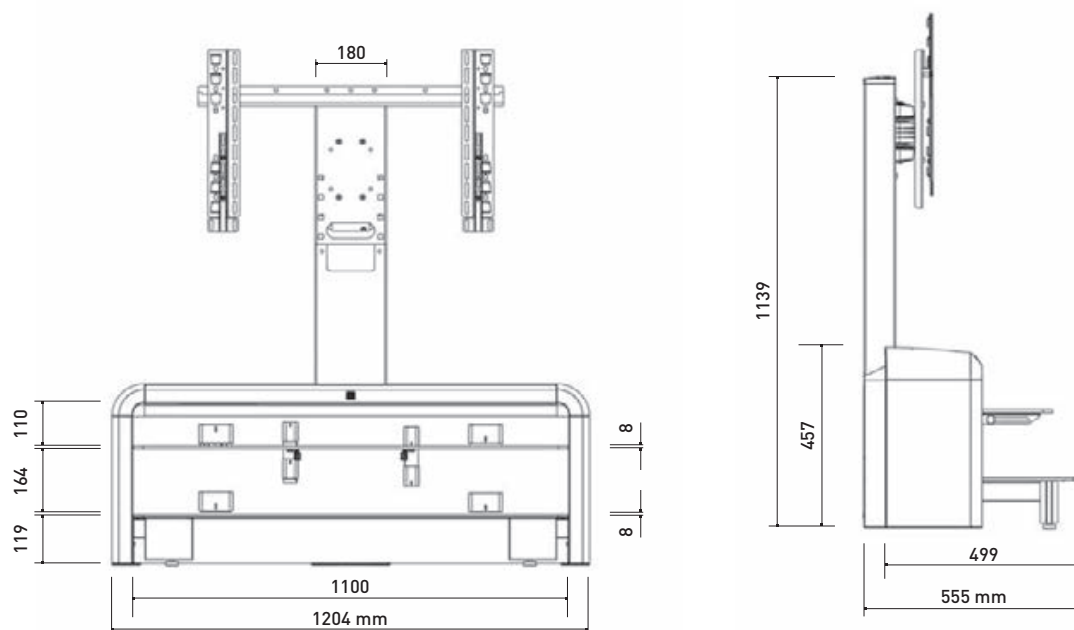

NON ASSEMBLED REFERENCES	Aluminium		Black		White	
	Ref.		Ref.		Ref.	
Louis Motorized TWIST® rotation & LIGHT®	Ref.	002569	Ref.	002657	Ref.	002664
	GENCOD	318528 002569 5	GENCOD	318528 002657 9	GENCOD	318528 002664 7
Louis manual swivel & LIGHT®	Ref.	002568	Ref.	002658	Ref.	002665
	GENCOD	318528 002568 8	GENCOD	318528 002658 6	GENCOD	318528 002665 4
Louis manual swivel	Ref.	002577	Ref.	002659	Ref.	002666
	GENCOD	318528 002577 0	GENCOD	318528 002659 3	GENCOD	318528 002666 1
Louis & LIGHT®	Ref.	002567	Ref.	002662	Ref.	002667
	GENCOD	318528 002567 1	GENCOD	318528 002662 3	GENCOD	318528 002667 8
Louis	Ref.	002576	Ref.	002663	Ref.	002668
	GENCOD	318528 002576 3	GENCOD	318528 002663 0	GENCOD	318528 002668 5

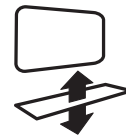
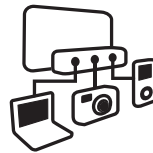
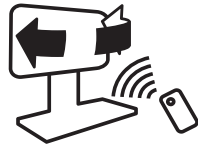
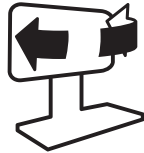

Aluminium
Ref. 2577
Ref. 2568
Ref. 2654
Ref. 2653

Aluminium
Ref. 2569
Ref. 2552

Black
Ref. 2659
Ref. 2658
Ref. 2644
Ref. 2647

Black
Ref. 2657
Ref. 2649

White
Ref. 2666
Ref. 2665
Ref. 2645
Ref. 2646

White
Ref. 2664
Ref. 2648

Aluminium
Ref. 2567
Ref. 2568
Ref. 2655
Ref. 2653
Ref. 2652

Black
Ref. 2662
Ref. 2658
Ref. 2657
Ref. 2671
Ref. 2647
Ref. 2649

White
Ref. 2667
Ref. 2665
Ref. 2664
Ref. 2672
Ref. 2646
Ref. 2648

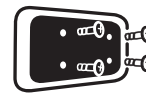

Up to
800x540 mm



Pedestal stand
models
26" - 50"
Stand with
column models
30" - 50"



60 KG

Guaranteed 10 years. Motorization, LIGHT MOTION® and connecting components are guaranteed 2 years

ASSEMBLED REFERENCES	Aluminium		Black		White	
	Ref.		Ref.		Ref.	
Louis Motorized TWIST® rotation & LIGHT®	Ref.	002652	Ref.	002649	Ref.	002648
	GENCOD	318528 002652 4	GENCOD	318528 002649 4	GENCOD	318528 002648 7
Louis manual swivel & LIGHT®	Ref.	002653	Ref.	002647	Ref.	002646
	GENCOD	318528 002653 1	GENCOD	318528 002647 0	GENCOD	318528 002646 3
Louis manual swivel	Ref.	002654	Ref.	002644	Ref.	002645
	GENCOD	318528 002654 8	GENCOD	318528 002644 9	GENCOD	318528 002645 6
Louis & LIGHT®	Ref.	002655	Ref.	002671	Ref.	002672
	GENCOD	318528 002655 5	GENCOD	318528 002671 5	GENCOD	318528 002672 2
Louis	Ref.	002656	Ref.	002642	Ref.	002643
	GENCOD	318528 002656 2	GENCOD	318528 002642 5	GENCOD	318528 002643 2

- Manual pan adjustment : +/- 2° (on models with column)
- 6 positions to adjust the screen height (on models with column)
- Upper adjustable cover to easily access the connection strip and to hide the connection cables behind the components
- LIGHT MOTION® system:
 - ambient lighting system managed by remote control
 - 2 LED strips
 - Automatic color variation function Adjustment of colour, intensity and variation speeds
 - Variation of colors according to sound intensity
 - 4 lighting preferences stored (on LIGHT® models)
- 2 height adjustable front feet
- Component shelves in black tempered lacquered glass: 8 mm thick
- Furniture frame in lacquered aluminium, black or white (depending on the models)
- Column in black grained epoxy painted steel
- Horizontal distance between fixing points: min. = 5 cm, max. = 81 cm
- Vertical distance between fixing points : min. = 5 cm, max. = 54.5 cm
- Max weight per shelf: 50 kg

Guaranteed 10 years. Motorization, LIGHT MOTION® and connecting components are guaranteed 2 years